

MaNima Module Industry

An Industrial Quality PWM and LED monitoring module



MaNima Pollux Industry Manual

Sensor Inputs

Measurements are possible with multiple sensor inputs. These readings can then be used for monitoring and conditions.

Ethernet switch

The MaNima Pollux doubles as an ethernet switch. The two ethernet ports on the Pollux are of the same network.

Digital/Potential inputs

There are 2 Digital/Potential inputs available on the MaNima Pollux. These can be used as triggers for actions.

PWM output

There are 8 PWM outputs available on the MaNima Pollux. These can be used to controller analogue LEDs or devices. PWM signal frequency is set at 340Hz.

Redundant setup

If the Pollux is used in an important installation that can't have malfunctions, it is possible to have a 2nd power source for the Pollux to ensure system reliability.

Monitoring and the cloud

The Pollux has been made with monitoring in mind. It is also possible to send this data to a cloud database.

Custom Software

The MaNima Pollux can be customized to communicate with your specific system. Contact MaNima Technologies for more information.

Easy-to-use GUI

The settings of the Pollux can easily be configured with the MaNima Configurator.

Increased reliability and protection

The MaNima Pollux is able to measure the Current and Voltage going through the PWM outputs.



Table of Contents

Table of Contents	2
Foreword	2
Safety Instructions	2
Technical Specifications	2
The MaNima Configurator	2
Opening the MC	2
The UI (User Interface)	2
Scanner	2
Network Configurator	2
LED Output	2
Current	2
NTC / LDR	2
I / O	2
Boot scene	2
Failure handler	2
Failure Handler Examples	2
Update	2
Installation & Wiring	2
Port Descriptions	2
Redundant Power Supply	2
Digital and Analog In/outputs	2
PWM Outputs	2
Reset & Indications	2
Recording and Playing	2
Failure Handler procedure	2
On-Board Temperatures	2
MaNima Interface Models	2
MaNima Network Overview	2
YouTube Tutorials	2
Contact Info	2



Foreword

First of all, thank you for using the MaNima Pollux Industry Monitoring and PWM Module!

The MaNima Pollux Industry Monitoring and PWM Module is an extension for the MaNima Magnus or Ignis and cannot operate without these. The MaNima Pollux is used for receiving sensor data (NTC, PTC, LDR etc) and sending this data to other MaNima products that can use that info to perform certain actions.

This manual has been made for the MaNima Pollux. It is important that anyone, who has to work with the MaNima Pollux, has read this manual.

MaNima Technologies



Safety Instructions

To make sure the product is properly handled, these precautions and safety instructions must be followed:

- Read the entire manual before installing the MaNima Pollux.
- These instructions should be handed out to the technicians/end-users responsible for installing and/or operating this product.
- The installations of this product should only be carried out by certified personal.
- Do not repair this device. Any unapproved modifications or reparations conducted by anyone other than MaNima Technologies B.V., will void product warranty.
- Do not connect the wiring to this product in any other manner than described in this manual.
- Never use this product when it is damaged, has visible damage, does not work correctly or when the product shows any other questionable behaviour that is out of the ordinary with electrical devices.
- Make sure the power source has no short-circuit.
- Make sure the input voltage is between 12-48VDC when power is turned on. Higher voltages might damage the product.
- Do not use more than one power source for the MaNima Pollux.
- To turn-off the MaNima Pollux, it must be disconnected from the power source.
- The MaNima Pollux must be protected against wet environments. Any moist will damage the product.



Technical Specifications

Weight	360 Gr
Dimensions	90 x 159 x 58 mm (B x L x H)
Mounting	Din rail 35mm
IP class	IP10
Wiring	Max. 2.5mm ² 14 AWG
Connectors	Ethernet switch terminal connector: RJ45 bus, 2 x 9 pins terminal block, 3 x 6P6C
Input voltage	12-48V DC
Own power consumption	9.6W
Ethernet	RJ45 compatible, for 10/100 Base-TX Ethernet with static IP address or DHCP
Input	DC1 12/48VDC power inputs (20A) DC2 12/48VDC power inputs (20A) 2 x Ethernet inputs/outputs 8 x NTC/LDR 2 x digital input optional Wi-Fi module 4 additional GNDs ArtNet/aSCN
Output	2 x Digital Output
Output DC1	4 channels x 5 A
Output DC2	4 channels x 5 A
Efficiency	Approx. 99.8%
Overvoltage Protection	Yes, up to 60 Volts
Short circuit protection	Short circuit protection on in-and outputs
Directives	CE, RoHs
Operating temperature	10°C ~ 40°C
On-Board temperature	Yes, must not exceed 60°C
Storage temperature	10°C ~ 60°C
Min-Max NTC measurement	-5°C ~ 100°C, 0.1°C degree resolution and +/-10% accuracy
Warranty	5 Years
GUI	MaNima configurator



The MaNima Configurator

In this chapter there will be everything you need to know about The MaNima Configurator regarding the MaNima Pollux.

The MaNima Configurator

The MC (MaNima Configurator) is the program used by the operator to configure the MaNima Pollux. The MC must be installed on a computer on the same network where the MaNima Pollux is connected to. To work with the MC it is recommended to first install and connect the MaNima Pollux to the network, since most (if not all) options won't be available without a connection between the computer and the MaNima Pollux.



The MaNima Configurator - Opening the MC

The MaNima Configurator can be downloaded here:

[Downloads | MaNima Technologies \(manima-technologies.com\)](https://manima-technologies.com)

The MC is opened by adding the “GUI” file to the computer. In this file the user will find all of the files needed to use this program. You can place the “GUI” in any file, but for this manual, the file will be placed in the desktop.

The computer on which the MC will be installed on, needs the newest version of Java. Java can be downloaded on: <https://www.java.com/en/>

- **Open the file with the left mouse button and double click on “ManimaSetupTool” (Highlighted blue on the image below)**

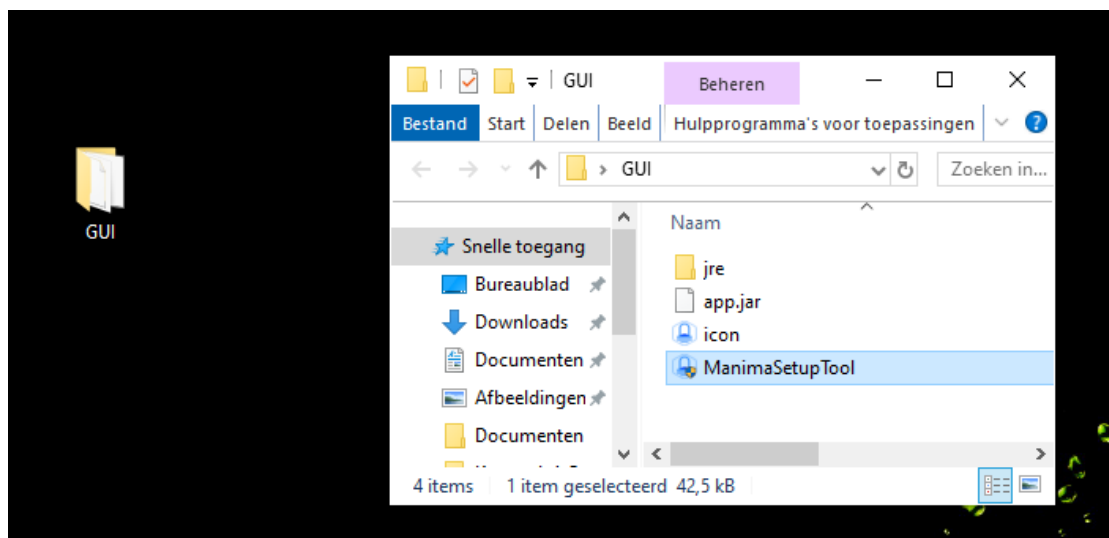

- **To open the MC directly from your desktop, you can create a shortcut using the right mouse button on the “ManimaSetupTool” file. The “ManimaSetupTool” can’t be placed outside the file, if done so, the MC will have an error.**

The MaNima Configurator- The UI (User Interface)

On the left side of The MC window there are multiple tabs which are used to configure the MaNima Pollux. A short explanation is given to each tab below:



The MaNima Configurator- Scanner

The Scanner is the tab used to search for different MaNima LED Interfaces. Follow the instructions below to configure your own device.

Make sure your computer and MaNima Pollux are connected to the same Ethernet/Wi-Fi network! The Interface should be in the scanner no matter what IP-adress it has.

Scanner						Currently editing: ManimaInterface (192.168.1.185)					
Device name	IP Address	MAC	Version	Software Version	Identify						
ManimaInterface	192.168.1.185	70:B3:D5:DD:90:30	Magnus 8	V 2.0.7	<input type="checkbox"/>						
▶ ManimaInterface ▷	192.168.1.186	70:B3:D5:DD:90:22	Magnus 8	V 2.0.7	<input type="checkbox"/>						

Currently editing: 'name' ('IP-address') = This shows which device is currently being edited.

Device name = Device name is the name given to a device. The user will know which device is which. You can change the device name in the "settings" tab

IP Address = The IP-address is the number given to a device. Using this address the user will know which device is which. It is possible that some Interfaces have the same IP address, make sure this is not the case!

MAC = The MAC address is the name given to the MaNima LED Interface by the manufacturer. MAC addresses are, unlike IP addresses, never identical to each other.

Version = This shows the version of the used hardware in the MaNima LED Interface.

Software Version = This shows the software version of the connected MaNima LED Interface.

Identify = If identify is switched on you can see which LED is controlled by that device, as they will be performing an RGB(W) test cycle.

▷ = This icon shows which Interface is the master of a group that is playing a scene.

▶ = This icon shows that the Interface has extensions connected. Press the symbol to see which.

⋮ = Press this button to connect or disconnect an extension.

To connect to The MaNima Pollux, Left click on the Interface. If the connection is successful, there should be “Currently editing: (IP-address)” instead of “Currently editing: None”.

Failure to Connect

If the MC is unable to find the MaNima Pollux, there are multiple things that may have gone wrong. So, make sure the following are correct:

1. The Connected MaNima Pollux is connected to the same network as the computer.
2. The network has a DHCP.
3. The IP-address is in the IP-address range of The MC.
4. The MaNima Pollux is powered or has the correct voltage.

Error Warning

The error warning is shown when the Interface has encountered a problem. In the example given here, the Interface has encountered a problem where there are too many universes in a port. This can be fixed by lowering the FPS in the live playing software.

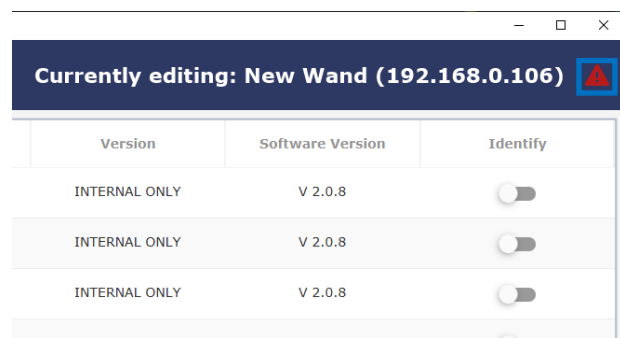

When such an error occurs, follow the instructions written in the error message.

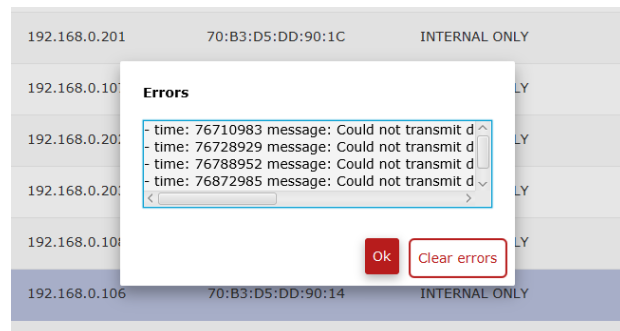

The MaNima Configurator - Network Configurator

The Network tab is used to edit the IP-address of the device. The IP-address can be edited manually by disabling the DHCP, or automatically by enabling the DHCP.

DHCP = turn off and on using the switch

Turning off DHCP enables the manual configuration of the network settings.

Network

DHCP

Set IP address 192.168.1.185

Set subnet mask 255.255.255.0

Set gateway address 192.168.0.1



The MaNima Configurator – LED Output

The Mapping tab is used to configure the PWM ports of the MaNima Pollux.

There are 8 available PWM ports on the MaNima Pollux that can assigned a specific universe or channel. These channels can then be controlled with ArtNet.

Output 1 enabled: Enable the Output to change settings.

Output 1 universe: This is the universe that is bound to the output.

Output 1 channel: This is the channel that is bound to the output.

Port1NTC: Select NTC's that should dim the Output.

PWM frequency: The frequency of the PWM signal.

Led output

PWM Output 1
PWM Output 2
PWM Output 3
PWM Output 4

Parameter name	Value
Output 1 enabled	<input checked="" type="checkbox"/>
Output 1 universe	<input type="text" value="201"/>
Output 1 channel	<input type="text" value="1"/>
Port1NTC	NTC1 <input type="checkbox"/> NTC2 <input type="checkbox"/> NTC3 <input type="checkbox"/> NTC4 <input type="checkbox"/> NTC5 <input type="checkbox"/> NTC6 <input type="checkbox"/> NTC7 <input type="checkbox"/> NTC8 <input type="checkbox"/>
PWM Frequency	343.33 Hz



The MaNima Configurator – Current

The Current tab enables the user to set parameters for each PWM Output.

Port 1 Peak Current: The measured peak current on the output.

Port 1 Average Current: The measured average current on the output

High and Low setpoints: These parameters are used with the ‘Set-up new handler’ button. Explanation can be found in the Set-up new handler chapter.

Port 1 Short circuit: When this box is checked there is a short circuit.

Current

Output 1 Output 2 Output 3 Output 4 Output 5 Output 6

Parameter name	Value
Port 1 Peak Current	1.32 A
Port 1 Average Current	1.32 A
Port 1 Peak current low setpoint	<input style="width: 80px;" type="text" value="0.0"/> A
Port 1 Peak current high setpoint	<input style="width: 80px;" type="text" value="10.0"/> A
Port 1 Average current low setpoint	<input style="width: 80px;" type="text" value="0.0"/> A
Port 1 Average current high setpoint	<input style="width: 80px;" type="text" value="10.0"/> A
Port 1 Short circuit	<input type="checkbox"/>



The MaNima Configurator – NTC / LDR

The parameters tab is used to configure the NTC ports of the MaNima Pollux.

Mode NTC/LDR: Select whether you are using a NTC or a LDR.

NTC/LDR Dim: This is the current level of dimming ranging from 0.0 (low) to 1.0 (high).

NTC6Temp: This is the current temperature of the NTC.

NTC/LDR 1 Disconnected dimming: Enable to turn off paired PWM outputs when NTC/LDR 1 is disconnected or has loose/unreliable wiring.

NTC6Outmax, NTC6Outmed and NTC6Outmin: Explanations is shown in the graph below.

Parameter name	Value
Mode NTC/LDR 1	NTC
NTC/LDR 1 Dim	0.0
NTC1Temp	24.38 deg C
NTC/LDR 1 Disconnected dimming	<input checked="" type="checkbox"/>
NTC1Outmax	10 %
NTC1Outmed	1 %
NTC1Outmin	0 %
NTC1Inmax	18.0 deg C
NTC1Inmed	12.0 deg C
NTC1Inmin	1.0 deg C

NTC6Inmax, NTC6Inmed, NTC6Inmin: Explanations is shown in the graph below.

When setting the parameters, keep in mind the ambient temperature and generated temperature of the LEDs to reduce risk of damages. The temperature that can be measured by the MaNima Pollux is between -15 deg C and 90 deg C.

To connect a MaNima Magnus to a MaNima Pollux as an extension, read the MaNima Magnus manual for more information.

The parameters can be configured using this graph:

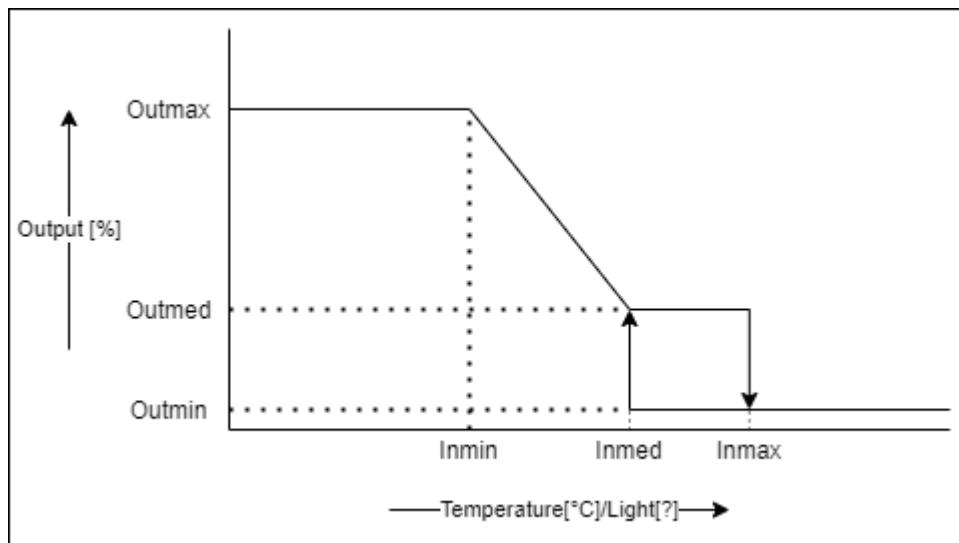

The MaNima Configurator – I / O

Digital In-and Outputs can be used to set triggers or failure handlers.

The DigitalInputs tab shows which Inputs are triggered by external systems.

Using the action handlers it is possible to set trigger requirements for each Input, as shown in the table below:

Note: When using digital inputs to trigger PWM outputs, fill in the Boot Scene for each output.

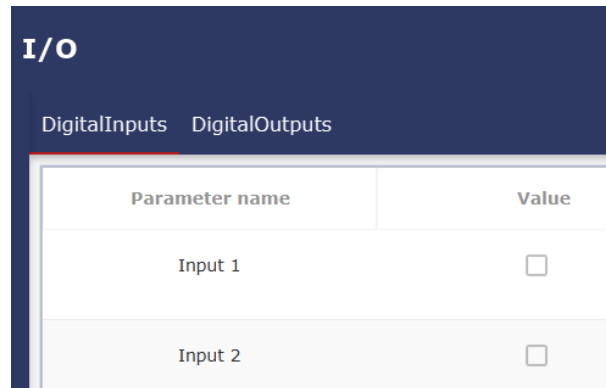

Trigger = Digital Input High		Digital Input	
	Action	High	Low
If input = Low	Toggle Output	Toggle	No Toggle
	Turn on output	Output On	Output Off
	Turn off output	Output Off	Output On
	Redundant output	Switched	Not Switched
	Switch on digital output	Switched	Not Switched
	Switch off digital output	Switched	Not Switched
If input = High	Toggle Output	No Toggle	Toggled
	Turn on output	Output On	Output Off
	Turn off output	Output Off	Output On
	Redundant output	Switched	Not Switched
	Switch on digital output	Switched	Not Switched
	Switch off digital output	Switched	Not Switched

In the DigitalOutputs tab it is possible to manually enable or disable the Digital outputs.

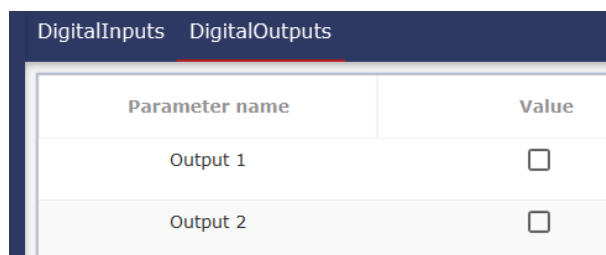

The MaNima Configurator – Boot scene

Boot scene is used to create standalone static scenes with the MaNima Pollux.

Frame 1 level: Set the light level between values 0-255

Frame 1 start delay: Ms until scene starts after start-up.

Frame 1 fade-in time: smoothly start a scene with the fade-in time in ms.

Frame 1 length: Length of the scene. 1ms is infinite.

Frame 1 universe: Set the universe where boot scene sends the data to. The LED outputs must be set on the same universe as the boot scene universe.

Boot scene	
Parameter name	Value
Frame 1 level	<input type="text" value="255"/>
Frame 1 start delay	<input type="text" value="0"/> ms
Frame 1 fade-in time	<input type="text" value="0"/> ms
Frame 1 length	<input type="text" value="1"/> ms
Frame 1 universe	<input type="text" value="201"/>
Frame 1 channel	<input type="text" value="1"/>

Frame 1 channel: Set the channel where boot scene sends the data to. The LED outputs must be set on the same channel as the boot scene universe.

Note: Boot scene cannot be used when ArtNet is being transmitted to the MaNima Pollux

Note: When using digital inputs to trigger PWM outputs, fill in the Boot Scene for each output.



The MaNima Configurator – Failure/Action handler

Failure handlers are used to set actions to measured values such as high current, digital inputs, temperature etc..

To enable a Failure/Action handler, press this button:

Set-up new handler

Depending on which tab you are present when pressing this button, a menu will show up with multiple options.

The first tab will be a 'setup failure'. Here you can set the conditions for a Failure Handler.

The second tab is the 'solutions tab'. Here you can set the action after the condition has been activated.

The last tab is the 'solution parameter'. Here you can set the parameters of the solution.



Setup Failure:

I / O

Digital input high: Digital input is turned on

Digital input low: Digital input is turned off

Digital input changed: Digital input is has changed.

Setup failure handler

Select failure

- Digital input high
- Digital input low
- Digital input changed

Previous Next **Cancel** Finish

Current

Peak current too high: Maximum peak current.

Peak current too low: Minimum peak current.

Setup failure handler

Select failure

- Peak current too high
- Peak current too low

Previous Next **Cancel** Finish

Current

Average current too high: Maximum average current.

Average current too low: Minimum average current.

Setup failure handler

Select failure

- Average current too high
- Average current too low

Previous Next **Cancel** Finish

Current

Output shortcircuit: Select this to enable safety precautions for shortcircuits.

Setup failure handler

Select failure

- Output shortcircuit

Previous Next **Cancel** Finish

NTC / LDR

NTC temperature too high: Use NTC(...)Inmax as a maximum value until this failure is activated.

NTC disconnected: Use this to set an action when the NTC has been disconnected.

NTC shortcircuit: Use this to set an action when the NTC has been short circuited

Setup failure handler

Select failure

- NTC temperature too high
- NTC disconnected
- NTC shortcircuit

Previous Next **Cancel** Finish



Setup Solution:

Turn off output: This disables the output

Redundant output: Enable the 2nd power output on the MaNima Pollux for redundancy

Switch on digital output: This turns on a digital output.

Switch off digital output: This turns off a digital output.

Setup failure handler

Select solution

Turn off output

Redundant output

Switch on digital output

Switch off digital output

Peak current too high: the value given to parameter 'Port (...) Peak current high setpoint' is the value for this failure.

Peak current too low: the value given to parameter 'Port (...) Peak current low setpoint' is the value for this failure.

Setup failure handler

Select failure

Peak current too high

Peak current too low

Solution parameters

Delay (ms): Delay in ms before the solution is enabled.

Cancel the solution after the failure is resolved: Cancel the solution after the failure is resolved.

Output number: set the PWM output number here, for example: 4 for PWM port 4.

Setup failure handler

Set solution parameters

Delay (ms)

Delay before this solution is enabled

Cancel if failure resolved

Cancel the solution after the failure is resolved

Output number

Number of the output

The MaNima Configurator – Failure Handler Examples

In this chapter there will be multiple examples of Failure Handlers for various cases.

Redundant setup:

In this example we are building a redundant setup for 2 LEDs. Using output 1 and 3 it is possible to create a redundant setup where if the primary output (1) can be replaced by the secondary output (3).

Output 1, step 1

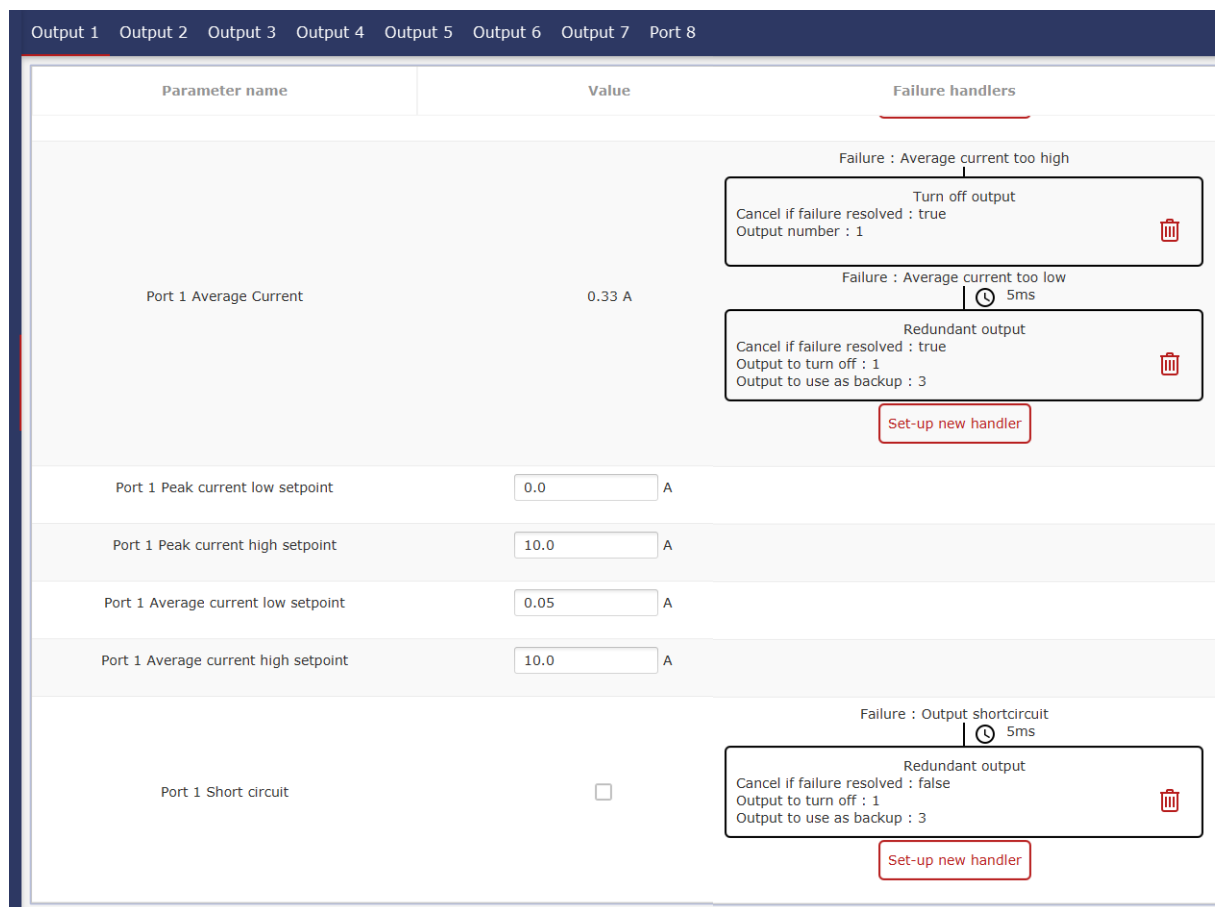

The screenshot shows the configuration interface for Output 1. At the top, there are tabs for Output 1 through Output 7 and Port 8. The main area is a table with columns for 'Parameter name', 'Value', and 'Failure handlers'.

Parameter name	Value	Failure handlers
Port 1 Average Current	0.33 A	<p>Failure : Average current too high</p> <p>Turn off output Cancel if failure resolved : true Output number : 1</p> <p>Failure : Average current too low 5ms</p> <p>Redundant output Cancel if failure resolved : true Output to turn off : 1 Output to use as backup : 3</p> <p>Set-up new handler</p>
Port 1 Peak current low setpoint	0.0 A	
Port 1 Peak current high setpoint	10.0 A	
Port 1 Average current low setpoint	0.05 A	
Port 1 Average current high setpoint	10.0 A	
Port 1 Short circuit	<input type="checkbox"/>	<p>Failure : Output shortcircuit 5ms</p> <p>Redundant output Cancel if failure resolved : false Output to turn off : 1 Output to use as backup : 3</p> <p>Set-up new handler</p>

The failure handlers have been set. When the MaNima Pollux measures a shortcircuit it will disable the output (1) and activate the secondary output (3).

When an average current above 10A is measured it will disable the output (1) and switch over to the secondary output (3)

Output 1, step 2

By creating a shortcircuit on CH1 and V+1, the failure handler will detect an 'output shortcircuit'. The MaNima Pollux will now disable the primary output (1) (Current = 0.01A) and activate the secondary output (3). The 'Port 1 short circuit' checkbox will also be red if a short circuit has been detected.

The failure handlers will turn red when they are activated.

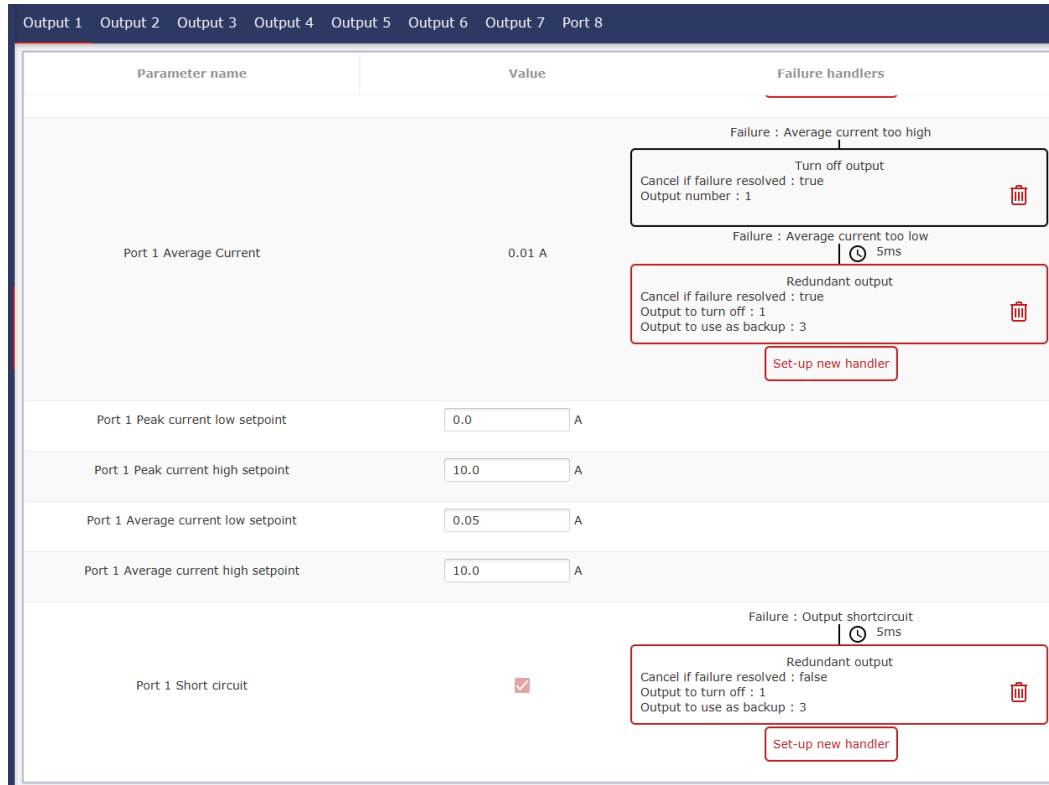

Parameter name	Value	Failure handlers
Port 1 Average Current	0.01 A	<p>Failure : Average current too high</p> <p>Turn off output Cancel if failure resolved : true Output number : 1</p> <p>Failure : Average current too low 5ms</p> <p>Redundant output Cancel if failure resolved : true Output to turn off : 1 Output to use as backup : 3</p> <p>Set-up new handler</p>
Port 1 Peak current low setpoint	0.0 A	
Port 1 Peak current high setpoint	10.0 A	
Port 1 Average current low setpoint	0.05 A	
Port 1 Average current high setpoint	10.0 A	
Port 1 Short circuit	<input checked="" type="checkbox"/>	<p>Failure : Output shortcircuit 5ms</p> <p>Redundant output Cancel if failure resolved : false Output to turn off : 1 Output to use as backup : 3</p> <p>Set-up new handler</p>

Output 3, step 2

When the failure handlers of Output 1 have been activated, output 3 has been activated.

This can be seen by the increased average current of the output, which has increased by 0.36A

For increased safety, this output has failure handlers for high currents and short circuits. When these are activated, the Output will be turned off.

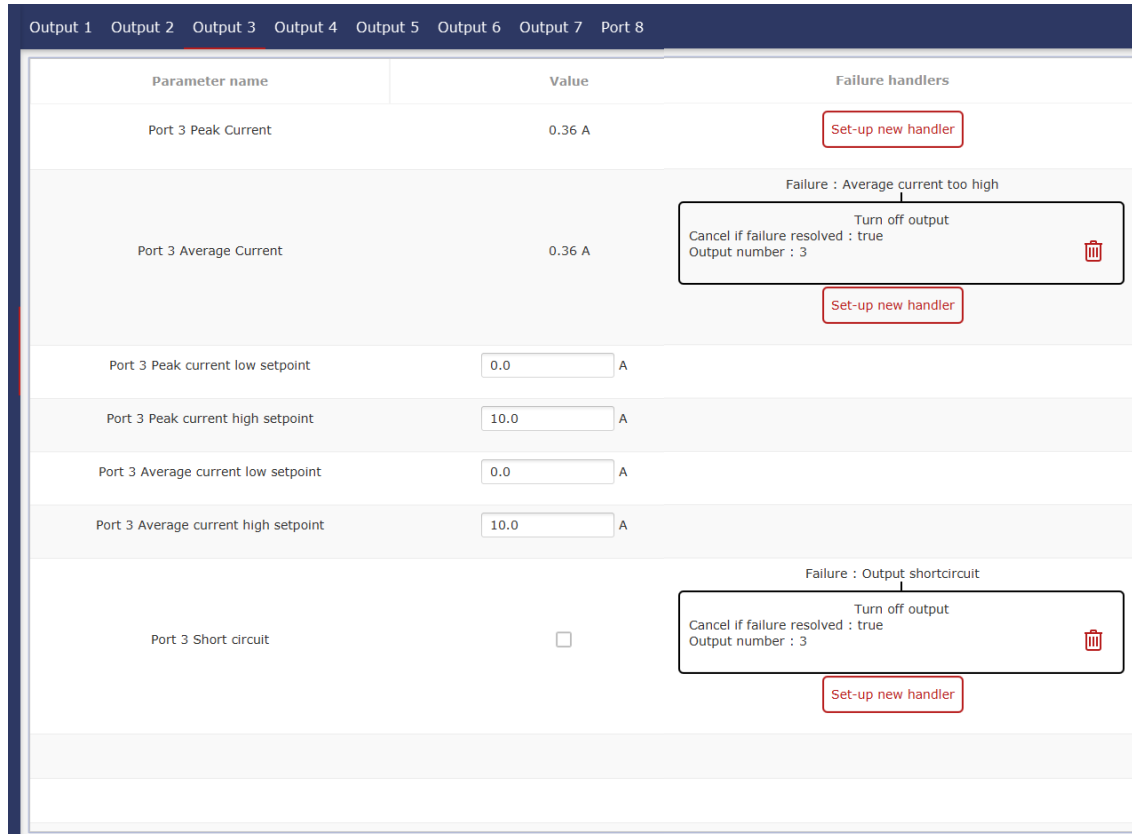

Parameter name	Value	Failure handlers
Port 3 Peak Current	0.36 A	Set-up new handler
Port 3 Average Current	0.36 A	<p>Failure : Average current too high</p> <div style="border: 1px solid black; padding: 5px;"> <p>Turn off output Cancel if failure resolved : true Output number : 3</p> </div> <p>Set-up new handler</p>
Port 3 Peak current low setpoint	<input type="text" value="0.0"/> A	
Port 3 Peak current high setpoint	<input type="text" value="10.0"/> A	
Port 3 Average current low setpoint	<input type="text" value="0.0"/> A	
Port 3 Average current high setpoint	<input type="text" value="10.0"/> A	
Port 3 Short circuit	<input type="checkbox"/>	<p>Failure : Output shortcircuit</p> <div style="border: 1px solid black; padding: 5px;"> <p>Turn off output Cancel if failure resolved : true Output number : 3</p> </div> <p>Set-up new handler</p>

The MaNima Configurator - Update

Because MaNima Technologies B.V. is constantly improving their products, there is an update tab available which allows the user to update the software version of the Interface without needing access to the physical Interface. This is only possible if there is an ethernet connection to the Interface.

Step by step:

1. Download the latest (or required) update from the MaNima website: [Downloads | MaNima Technologies \(manima-technologies.com\)](https://manima-technologies.com/Downloads)
2. Select the downloaded file by pressing the 'Select file' button.
3. Make sure the correct file is selected, then press 'Start update'.

To update a group of MaNima Interfaces, press Batch update and select which Interfaces you want to update.



When encountering problems during your use of the MaNima Interface, make sure the latest update of the software is downloaded on the MaNima Interface. Also make sure the latest version of the MaNima Configurator is installed.

Make sure that the downloaded update file has the correct license. A Magnus 2 update file is not compatible with a Magnus 8 update file.

Installation & Wiring

In this chapter there will be a description about every available port on the MaNima Pollux.

For additional wiring diagrams, visit the MaNima Technologies website → support and download the wiring diagrams. Link: [Downloads | MaNima Technologies \(manima-technologies.com\)](https://manima-technologies.com/downloads).



Installation & Wiring - Port Descriptions

Descriptions of ports from top left to bottom right:

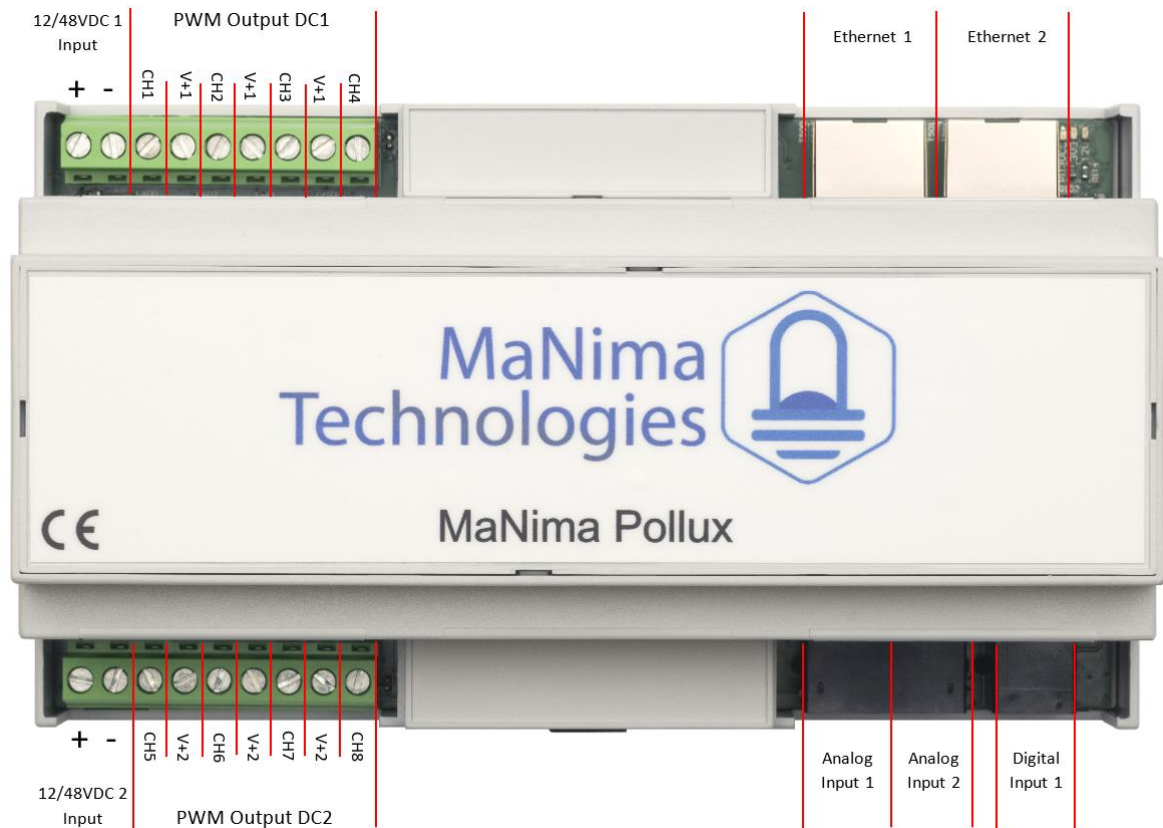

12/48V DC1: Power input for power source 1. Corresponds with ‘DC1 PWM Outputs’.

12/48V DC2: Power input for power source 2. Corresponds with ‘DC2 PWM Outputs’.

DC1 PWM Outputs: 4 x PWM Outputs and 3 x V+. Corresponds with ‘12/48V DC1’ Power input.

DC2 PWM Outputs: 4 x PWM Outputs and 3 x V+. Corresponds with ‘12/48V DC2’ Power input.

Analog input 1: Input for analog sensors. See next page for the pinout.

Analog input 2: Input for analog sensors. See next page for the pinout.

Digital input 1: In-and outputs for the digital sensors. See next page for the pinout.

Ethernet 1 and 2: RJ45 connector Ethernet switch for connecting the Pollux to the network.

Installation & Wiring – Redundant Power Supply

There are 2 different power inputs on the MaNima Pollux. These are designated as '12/48VDC 1 Input' and '12/48VDC 2 Input'. The MaNima Pollux can operate its monitoring capability when one of the two inputs is supplied with 12/48VDC. Only half of the PWM outputs can be used if there is only one power input used.

With the use of failure handlers it is possible to create redundant setups where the MaNima Pollux can automatically switch between power supplies when failures are detected (such as short circuits, over currents etc..)

Each side can support up to 20A. It is recommended to use 2 power supplies, one for each input.

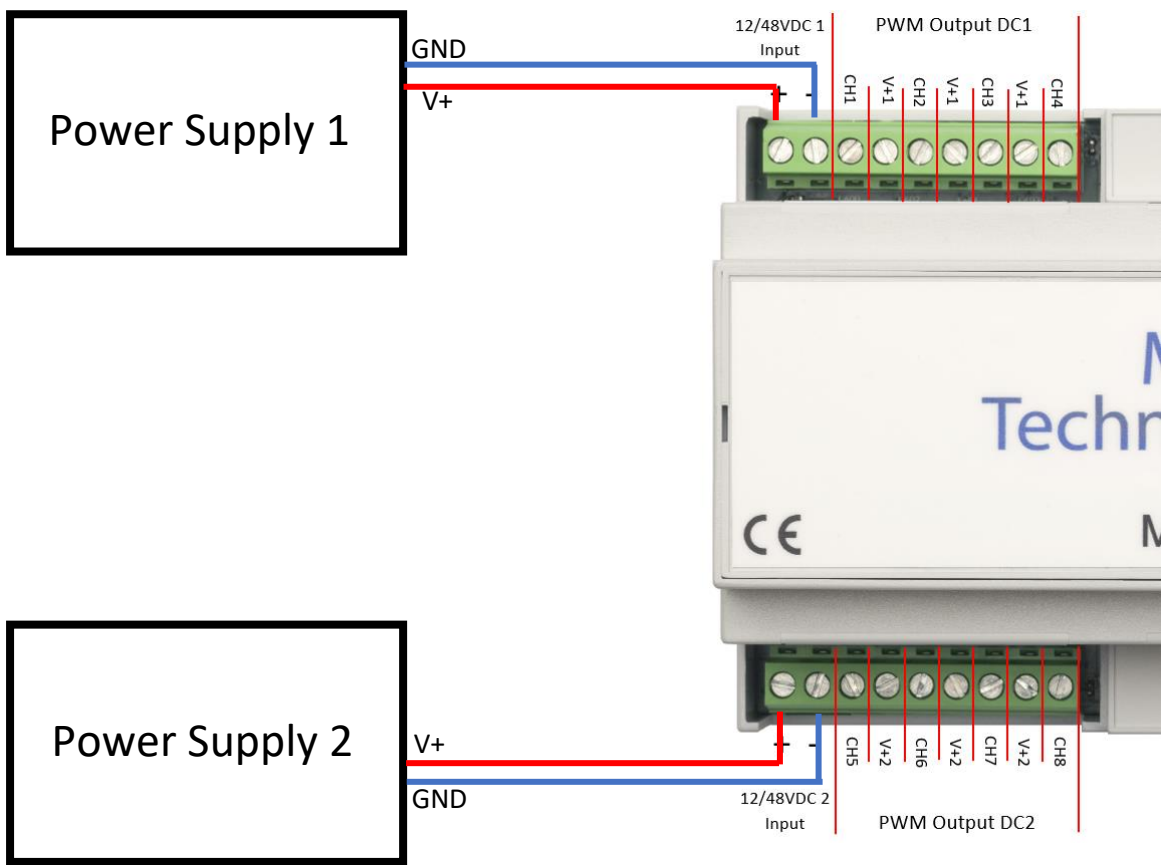

Installation & Wiring – Digital and Analog In/outputs

There are 3 6P6C connectors available on the MaNima Pollux. The left 2 are used for the Analog Sensor Inputs, and the right one is used for the Digital In-and outputs.

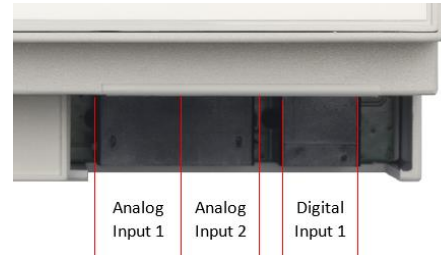

These are the pinouts for each connector:

6P6C Connector as seen from the front:

Analog 1			
Pin	Function	Max Current	Max Voltage
1	GND	50mA	0,1V
2	GND	50mA	0,1V
3	NTC / LDR 1_1	50mA	3,3V
4	NTC / LDR 2_1	50mA	3,3V
5	NTC / LDR 3_1	50mA	3,3V
6	NTC / LDR 4_1	50mA	3,3V

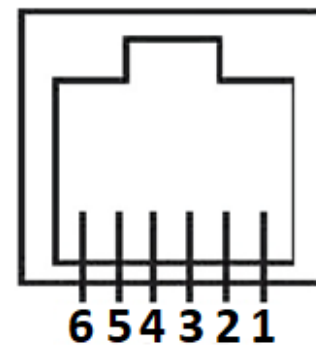

Analog 2			
Pin	Function	Max Current	Max Voltage
1	GND	50mA	0,1V
2	GND	50mA	0,1V
3	NTC / LDR 5_1	50mA	3,3V
4	NTC / LDR 6_1	50mA	3,3V
5	NTC / LDR 7_1	50mA	3,3V
6	NTC / LDR 8_1	50mA	3,3V

Digital 1			
Pin	Function	Max Current	Max Voltage
1	GND	50mA	0,1V
2	GND	50mA	0,1V
3	Digital Out 2_1	50mA	300V
4	Digital Out 2_2	50mA	300V
5	Digital In 1	5mA	48V
6	Digital in 2	5mA	48V

Installation & Wiring – PWM Outputs

PWM-Outputs are used to power analogue LEDs.

CH1 to CH8 are PWM controlled GND's.

V+1 and V+2 are used as a positive voltage and corresponds to input 1 and 2 respectively.

The PWM frequency of the PWM outputs can all be individually adjusted in the LED output tab in the MaNima Configurator

The corresponding universes and channels can be configured for each PWM output in the Led output tab.



Installation & Wiring – Reset & Indications

The MaNima Pollux has multiple LED indications present on its circuit board. It also has a single reset button that can be used to manually reset the Pollux when this is not possible with the MaNima Configurator.



Recording and Playing

The MaNima Pollux can't record scenes by itself, this feature is unlocked by acquiring a MaNima Magnus. By pairing the MaNima Pollux with the MaNima Magnus, it is possible to record the MaNima Pollux and play the scene back later.



Failure Handler procedure

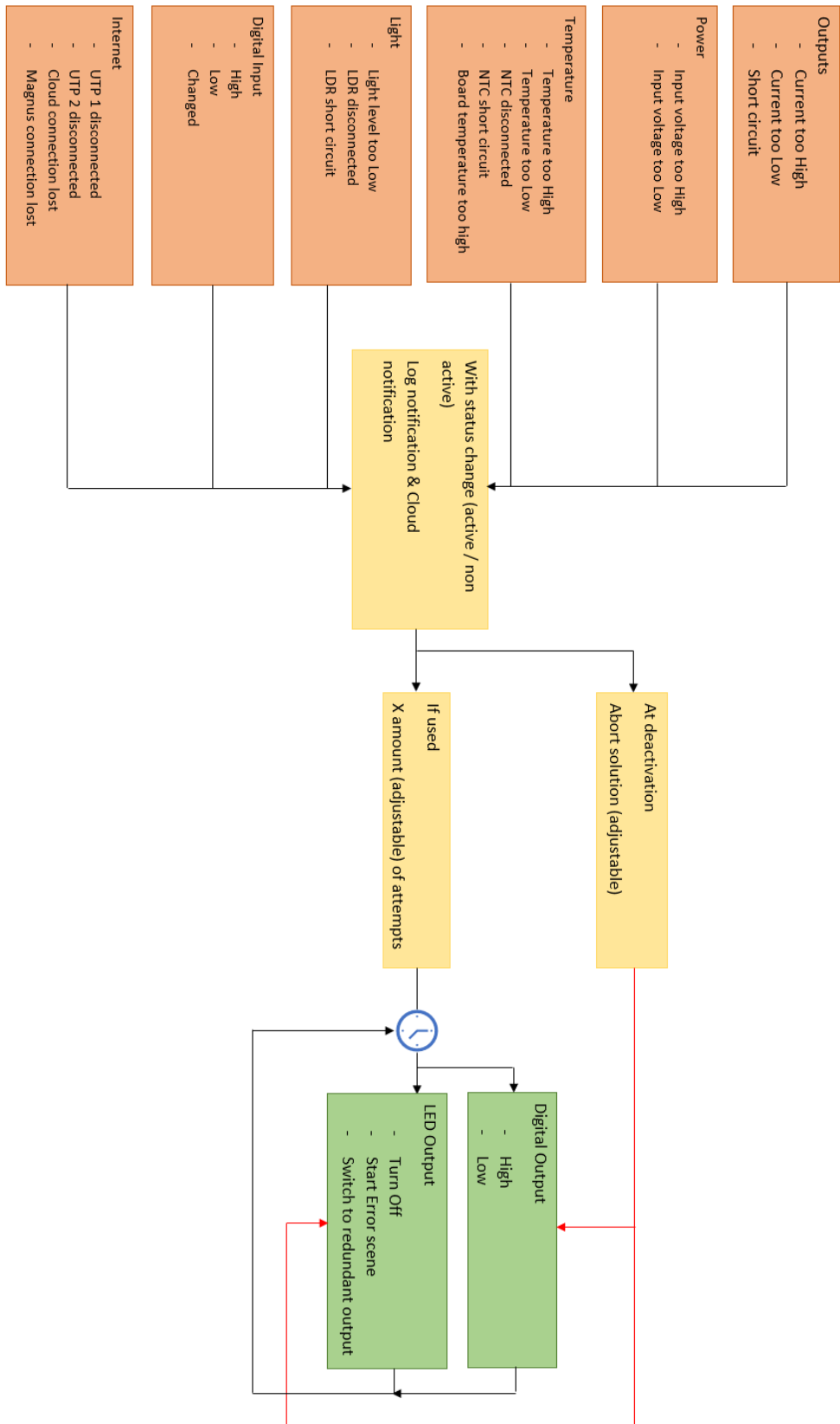

On-Board Temperatures

The MaNima Pollux has a advised maximum board temperature of 60°C. The On-Board temperature is measured in real time and can be seen in the MaNima Configurator in the NTC / LDR tab.

NTC / LDR		Currently editing: Pollux	
NTC / LDR 1		NTC / LDR 2	
NTC / LDR 3		NTC / LDR 4	
NTC / LDR 5		NTC / LDR 6	
NTC / LDR 7		NTC / LDR 8	
Board			
Parameter name	Value	Remarks	Failure
Board temperature	27.5 deg C		

When using the MaNima Pollux in an ambient temperature of 40°C without active cooling do not exceed the maximum currents as seen in the 'Technical Specifications' table.

It is possible to exceed the maximum currents, but it is most important to keep a maximum board temperature of 60°C. This can be done by actively/passively cooling the MaNima Pollux.



MaNima Interface Models

	Models	MaNima Magnus	MaNima Ignis	MaNima Nexus	MaNima Pollux
<i>Functions</i>					
<i>SPI outputs</i>	✓	✓	✗	✗	
<i>DMX</i>	✓	✓	✗	✗	
<i>SPI recording and playing</i>	✓	✗	✗	✗	
<i>Segments</i>	✗	✓	✗	✗	
<i>Digital Triggers</i>	✓	✓	✗	✓	
<i>Analog Triggers</i>	✓	✓	✗	✓	
<i>Sensor Inputs</i>	✗	✗	✗	✓	
<i>PWM output</i>	✗	✗	✗	✓	
<i>Wi-Fi**</i>	?	?	✓	?	
<i>DALI</i>	✗	✗	✓	✗	
<i>Ethernet</i>	✓	✓	✓	✓	
<i>Art-Net / sACN</i>	✓	✗	✓	✗	
<i>UDP</i>	✓	✓	✓	✗	
<i>Custom API</i>	✗	✓	✓	✗	
<i>MaNima Cloud</i>	✗	✗	✓	✗	
<i>Redundant setup</i>	✗	✗	✗	✓	

*The amount of universes depend on the licence

**When yellow; WiFi is available with an additional module



Overview

MaNima Pollux

Overview

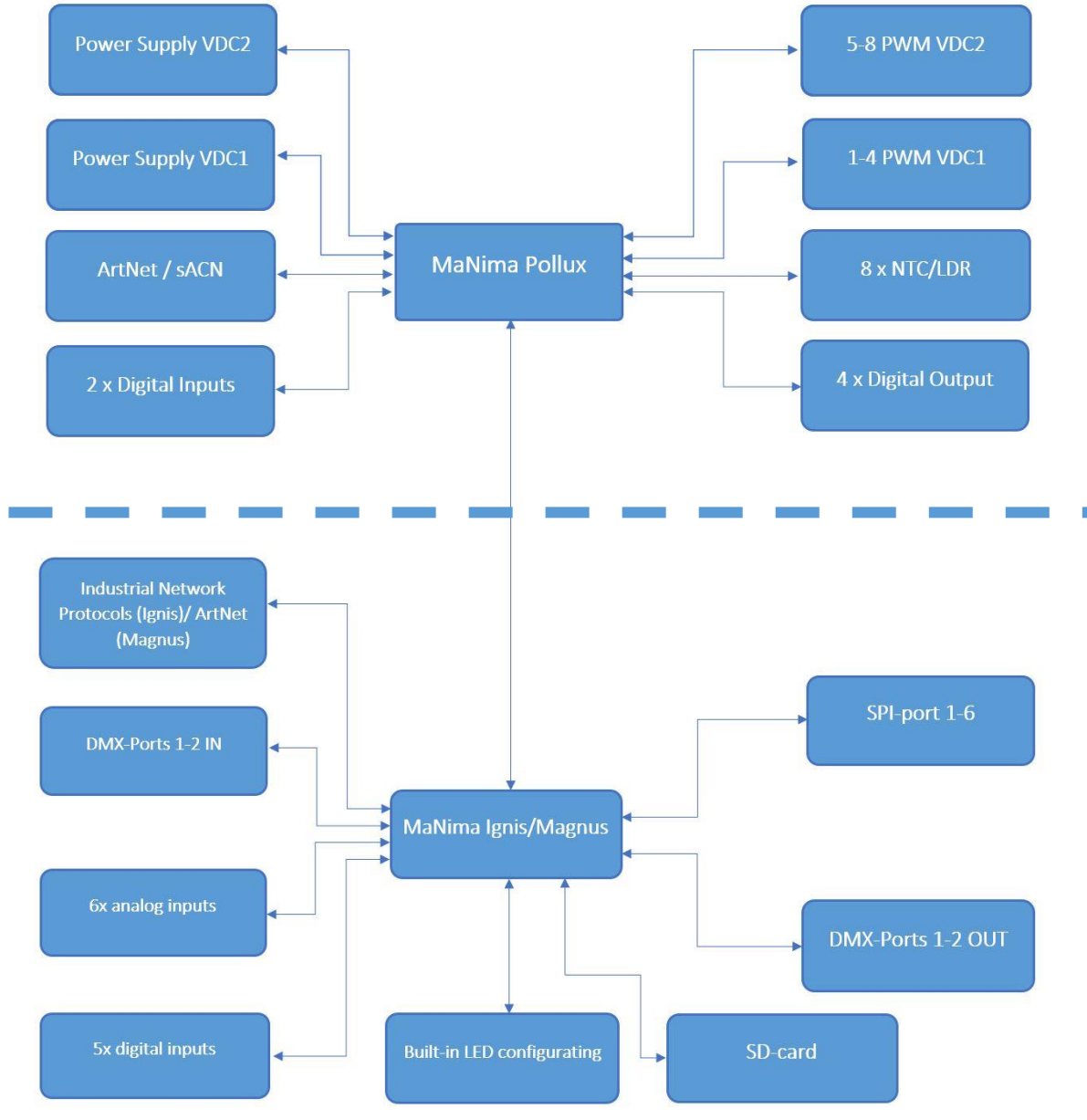

MaNima Network Overview

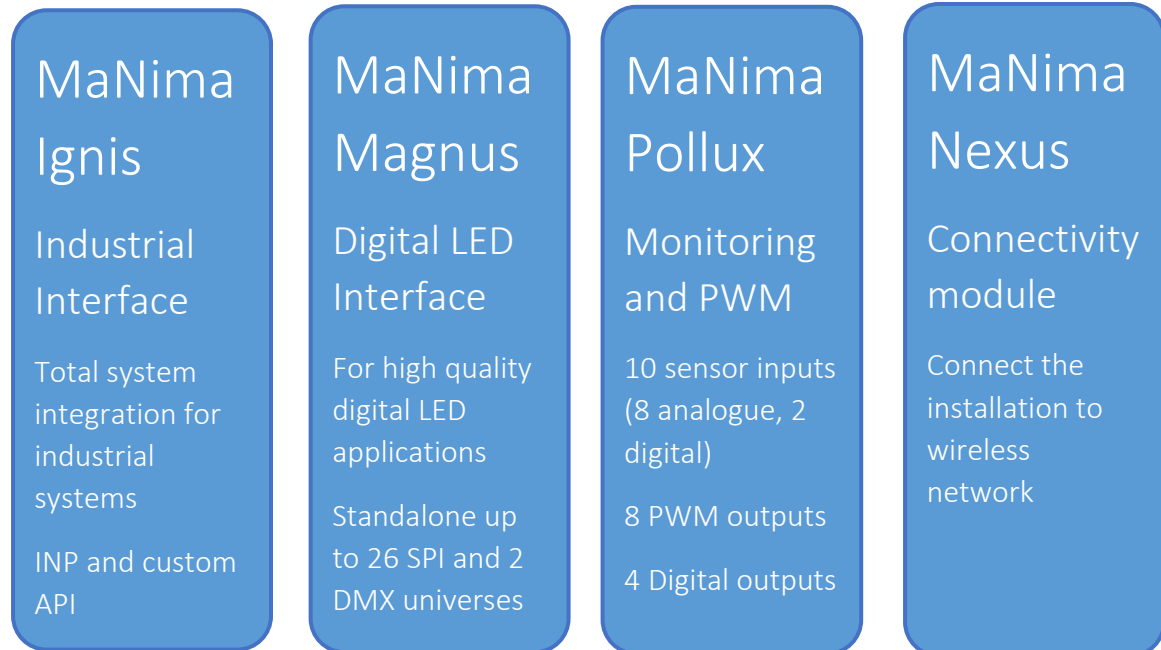

MaNima Magnus: The MaNima Magnus Architectural LED Interface is a professional LED controller with an industrial design made for operating digital LED installations. The interface is also able to control multiple protocols at once.

MaNima Ignis: The MaNima Ignis Industrial Interface is a LED interface designed for the industrial market. The MaNima Ignis is a stable and reliable platform that is used in the Industry for operating LEDs. The MaNima Ignis can communicate with existing systems.

MaNima Nexus: The MaNima Nexus is a module used for connecting advanced and complex systems to a network of MaNima products.

MaNima Pollux: The MaNima Pollux is an industrial PWM driver and LED monitoring module made for the professional market. The MaNima Pollux is a versatile device which can fulfil many different tasks. The MaNima Pollux has been designed to be reliable, stable and fail-safe.



YouTube Tutorials

YouTube Tutorial links:

[MaNima Tutorial 1 Connecting the Interface - YouTube](#)

[MaNima Tutorial 2 Mapping and Recording digital LEDs - YouTube](#)

[MaNima Tutorial 3 Synchronized recording and playing - YouTube](#)

[MaNima Tutorial 4 DMX Functions - YouTube](#)

[MaNima Tutorial 5 Digital Triggers - YouTube](#)

[MaNima Tutorial 6 Analog Triggers - YouTube](#)

[MaNima Tutorial 7 Loop Functions - YouTube](#)

[MaNima Tutorial 8 Updating with Ethernet - YouTube](#)

[MaNima Tutorial 9 Using Segments - YouTube](#)

[MaNima Tutorial 10 Connecting the MaNima Pollux - YouTube](#)

[MaNima Tutorial 11 Configuring NTC inputs - YouTube](#)

[MaNima Tutorial 12 Current and Failure handlers - YouTube](#)

[MaNima Tutorial 13 Inputs and Outputs - YouTube](#)

[MaNima Tutorial 14 Installing the MaNima HMI Touchscreen - YouTube](#)



Contact Info

MaNima Technologies B.V.

Address:

Hastelweg 260-B
5652 CN, Eindhoven
Netherland

Contact:

E: info@manima-technologies.com
W: www.manima-technologies.com
T: 040 202 49 04

Dutch chamber of Commerce registration number/KvK-nummer: 71614605

YouTube

Link: [MaNima Technologies - YouTube](#)

